



BOLD NEW STYLE IMPOSING NEW PRESENCE

INTRODUCING THE INNOVA CRYSTA IN A NEW AVATAR



**NEW
INNOVA | UNMATCHED
CRYSTA | UNRIVALED**



UNMATCHED UNRIVALED

The Innova Crysta has been India's favourite family car for over 15 years. It has been followed by many, but matched by none. Its power, comfort and safety are unparalleled and part of automobile folklore.

Now the legendary Innova's capabilities are further enhanced with an imposing new front silhouette that gives it a bold stance like no other. The new Innova Crysta also gets stunning diamond-cut alloy wheels that project elegance. In short, the new Innova Crysta is in a league of its own.

Distinctly designed, its exterior body lines are only a prelude to the luxuries that's inside. Nothing can prepare you for the unbelievable space and plushness of its luxurious cabin.

Replete with cozy, leather[#] reclining seats that give you more legroom, and ride quality that's second to none, the new Innova Crysta is truly beyond compare. Add to that its raw, yet refined power delivery and you have a car that gives you a truly unmatched and unrivaled travelling experience.

[#]Mix of genuine and synthetic leather.

Imposing Chrome Surround Piano Black Grille

New bold front grille with chrome surround and stylish CRYSTA embossed bumper

Enticing Diamond-cut Alloys

Gives more elegance & presence to your drive



Front Clearance Sonar with MID Indication

Ensures safe parking in tight spaces

Piercing LED Headlamps

Improves visibility and enhances the confident stance

UNMATCHED DESIGN



The new Innova Crysta's design is matchless. Thanks to its distinctly styled, bold front grille and bumper, it exudes unmistakable road presence that takes it miles ahead of the rest.

Welcome Lamps / Provides a warm welcome everytime you approach the new Innova Crysta



Blue Illumination, 3-dimensional Combination Meter with Large TFT MID

Blue illumination, 3-dimensional combination meter with large TFT MID with drive information, cost calculator and telephone/navigation display adds to the car's intelligence



UNRIVALED CONNECTIVITY



Apple CarPlay | Android Auto

Access your favourite Apple and Android apps

The elegant driver dashboard is the control centre of the new Innova Crysta. It features 20.32cm display with Android Auto and Apple CarPlay Connectivity*, using your smartphone you can also access advanced connectivity* features like Walk to Car, Geo Fencing & Real Time Vehicle Tracking.

INNOVA CONNECTED - SECURITY REDEFINED*

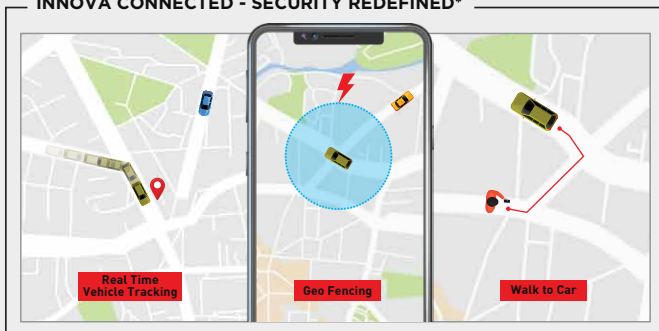

*Recommended accessory. Not standard fitment.

UNMATCHED COMFORT

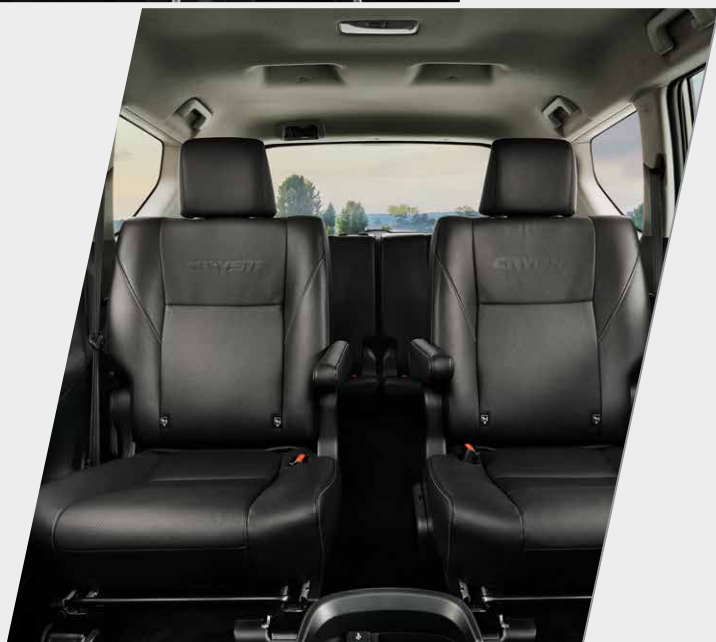

Plush Leather[#] Seats | Choose from a range of premium leather[#] seats in black and camel tan

[#]Mix of genuine and synthetic leather.

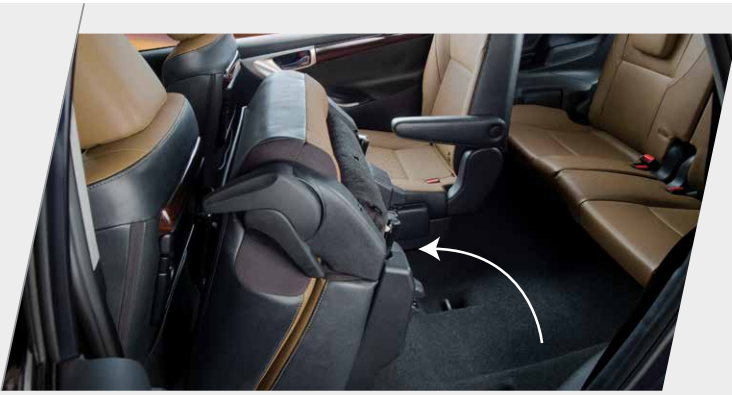

One-touch Tumble Second Row Seat | Gives you easy access to the third row seats

The interior of the new Innova Crysta is unequalled in its refinement and class. While the sheer amount of space will thrill you, the built-to-last quality will mesmerise you. Be it the choice of premium leather# seats, enhanced legroom or soft-touch materials, the new Innova Crysta spells unparalleled comfort. So whether it's a long journey or a short trip, it gives you the calm and composure needed for you to arrive in style and confidence at your destination.



Ambient Illumination | Gives the cabin a luxurious look and feel



Upper Glove Box with Cooling | Keeps your beverages cold and refreshingly fresh



Foldable Seatback Table with Cup Holder
| *Keeps your knick knacks safely when on the go*



Wood Finish Interior Panels | *Gives a premium and luxurious look*



Easy Slide Front Passenger Seat
| *Adjusts the rear legroom for more comfort*



Smartphone Holder with USB Port
| *Keeps you connected when on the move*

UNRIVALED PERFORMANCE



The new Innova Crysta has oodles of power under its hood, yet is unwaveringly efficient. And that's not all. It also offers refined driving dynamics for a smoother, more surefooted ride thanks to its robust chassis, sturdy suspension and slick transmission.



ECO & POWER Drive Modes | *ECO mode for optimum fuel economy and POWER mode for sharper acceleration response*



Powerful GD Diesel Engine

The new Innova Crysta is powered by a GD diesel engine with further evolved low-speed torque. It has improved fuel economy while torque in the low and medium speed ranges have been considerably increased.



Improved Suspension with Pitch & Bounce Control

Keeps cabin movement to a minimum and maintains a smooth ride on rough roads

UNMATCHED SAFETY



The new Innova Crysta is not only powerful and comfortable, it's safe too. Because, at Toyota we give your safety the utmost priority.

The new Innova Crysta protects you and your family with 7 U SRS Airbags## during any unforeseen event. Vehicle Stability control, Anti-lock braking, electronic brake force distribution, brake assist and the like ensure safety and stability even while high-speed braking.

The tough chassis and the acclaimed GOA Body keeps body roll to a minimum and ensures maximum protection by evenly distributing any impact on the car throughout the body of the car.

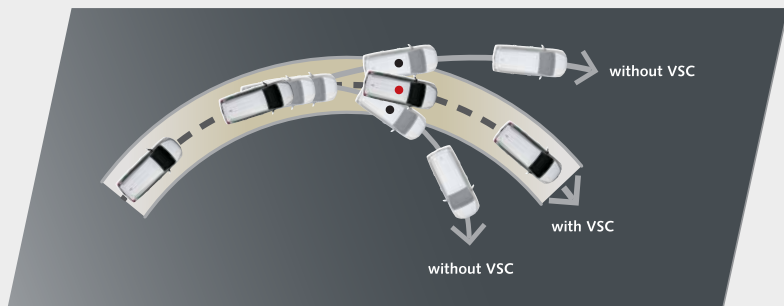

Vehicle Stability Control

Automatically controls both vehicle brakes and engine output during over steer or under steer while the vehicle is making a turn, ensuring vehicle stability

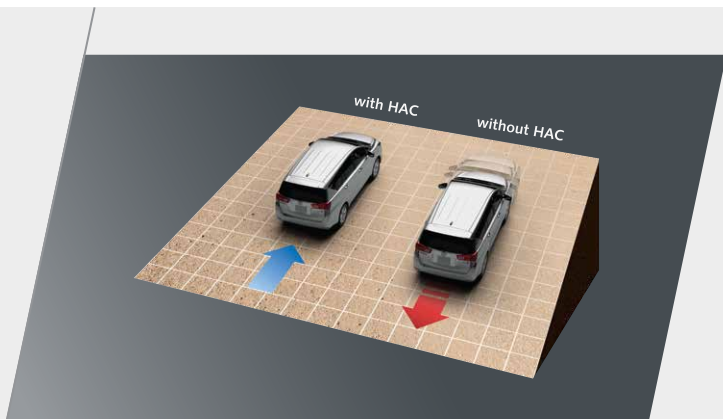

Hill-start Assist Control

Automatically controls the brakes suppressing vehicle rollback when starting off on a slope, reducing the burden on the driver

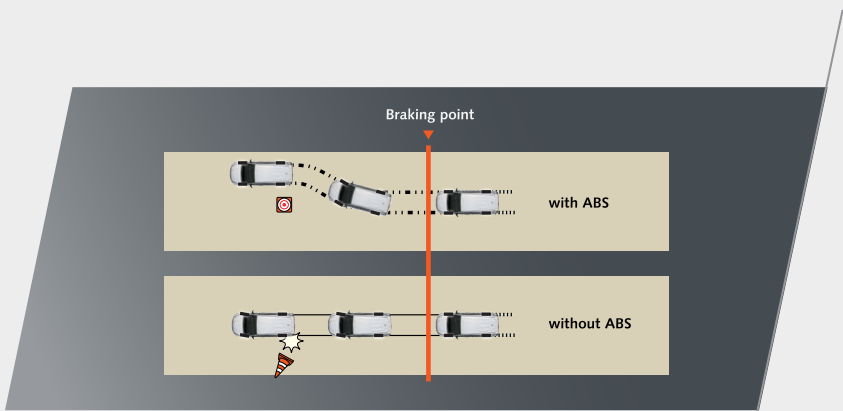

Anti-lock Braking System

Prevents wheels from locking and enables greater manoeuvrability and steering control

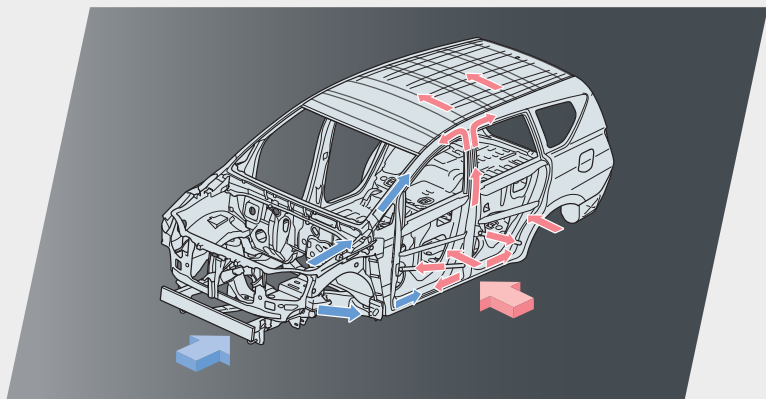

GOA Body

High strength body structure that effectively absorbs impacts and distributes it evenly during unforeseen collisions, thereby reducing passenger and pedestrian injuries

##For more details on the functioning of Airbags please refer to the owner's manual.

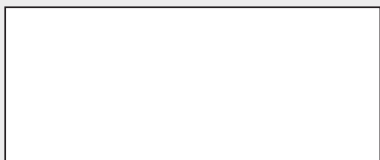

Super White

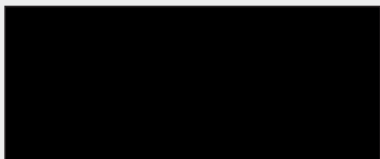

Attitude Black Mica

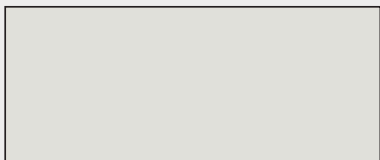

Platinum White Pearl



Avant-Garde Bronze Metallic

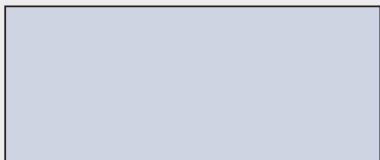

Silver Metallic



For more information, visit www.toyotabharat.com You can Talk to Toyota at 1800-309-0001 (BSNL/MTNL Toll Free No.) or +91-80-45059000 (Direct No.)

Note: Exterior features shown are not standard items and are available as Toyota Genuine Accessories. Vehicles pictured and specifications detailed in this brochure may vary between models and equipment. Addition of extra features may change figures in this chart. Toyota Kirloskar Motor Pvt. Ltd. reserves the right to alter the details of specifications and equipment without a notice. Actual colour of the vehicle body & upholstery might differ slightly from the images depicted in this brochure. Features are grade specific.